

**POWER
SHOT**

HOT WASH

HW1310

HOT WATER
CLEANER



INSTRUCTION MANUAL

GB - CONTENTS	Pag.
Preparation	3
Description of symbols	4
Introduction	5
General warnings for installation and use	5
Intended use	8
Preliminary operations	8
Use	10
Advise on using detergents	11
Maintenance	11
Periods of inactivity	13
Scrapping	13
Trouble-shooting	14

English

Congratulations! We wish to thank you

for buying this cleaner. You have shown that you do not accept compromises: *you want the best*. We have prepared this manual to enable to fully appreciate the qualities and high performance that this cleaner can offer you. Please read it completely before using the machine. The CE mark on your cleaner shows that it has been constructed in compliance with the European Standards on safety.

We can also offer you a wide range of cleaning machines such as: **VACUUM CLEANERS, FLOOR CLEANERS, FLOOR SWEEPERS** and a complete range of **ACCESSORIES, CHEMICALS** and **DETERGENTS** suitable for cleaning all kinds of surfaces. Ask your Dealer for the complete catalogue of our products.

ORIGINAL INSTRUCTIONS

The text has been carefully checked, however any misprints should be notified to the manufacturer. The manufacturer also reserves the right to alter and update this publication without prior notice for the sake of product improvement.

All reproductions of this manual, in whole or in part, are forbidden without the manufacturer's authorization.

PREPARING THE CLEANER

Fitting the lance.

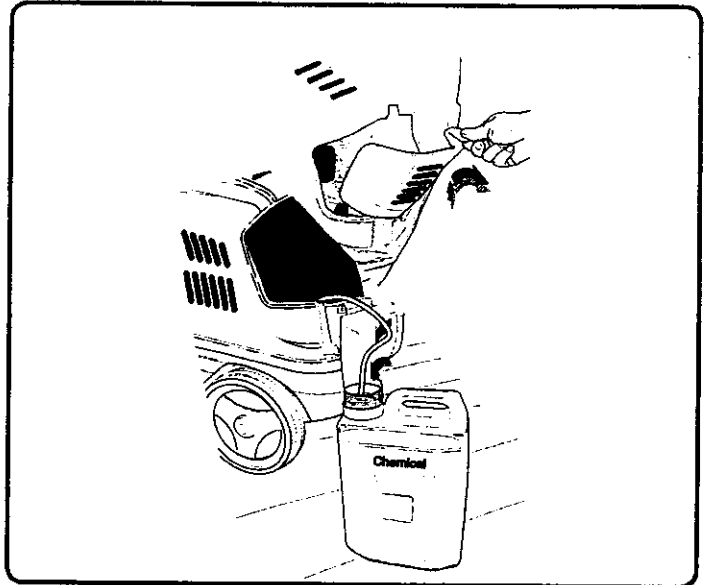
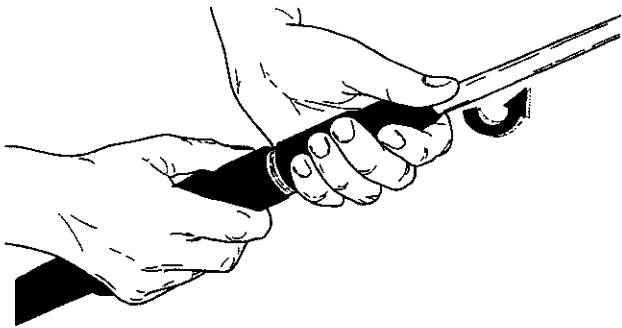

Water circuit connection.

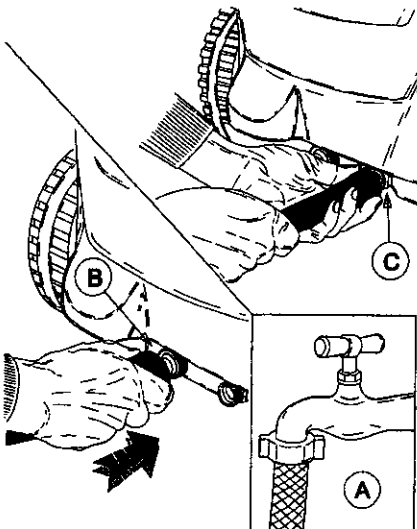

Electrical connection.

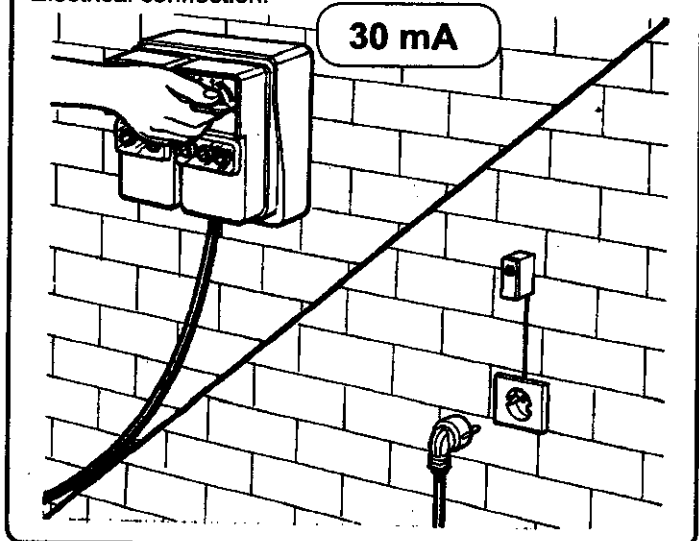

Continue reading this manual without connecting the cleaner to the power mains and the water supply.

English

DESCRIPTION OF SYMBOLS ON THE CLEANER

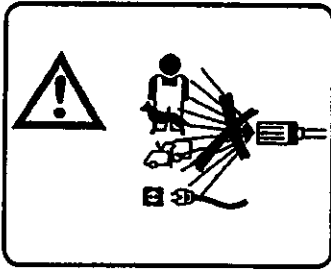

DO NOT DIRECT THE JET AGAINST PEOPLE, ANIMALS, POWER SOCKETS OR THE MACHINE IT SELF.

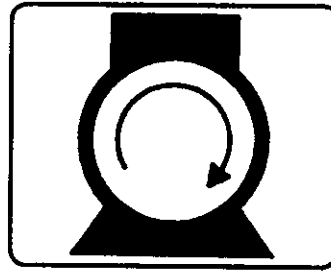

SWITCHING OF THE PUMP MOTOR.

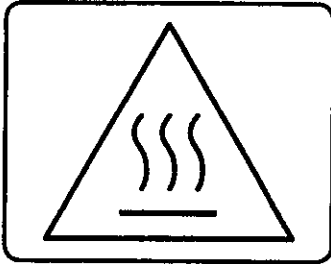

ATTENTION: RISK OF BURNS.

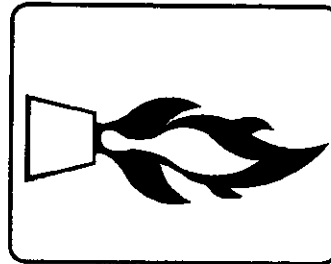

LIGHTING THE BURNER.

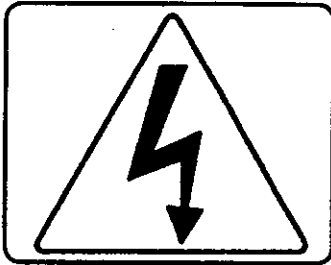

ATTENTION: RISK OF ELECTRIC SHOCK.

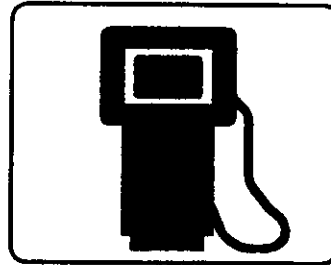

FUEL (DIESEL).

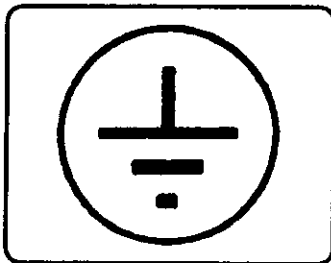

EARTH.

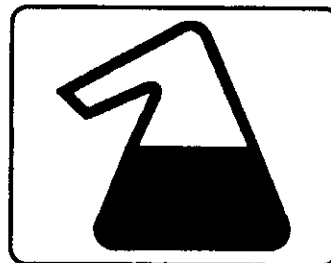

CHEMICALS (DETERGENT).

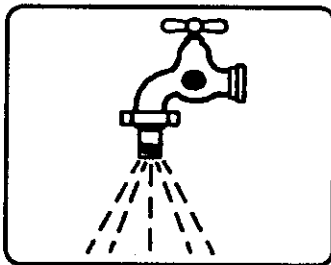

WATER INPUT.

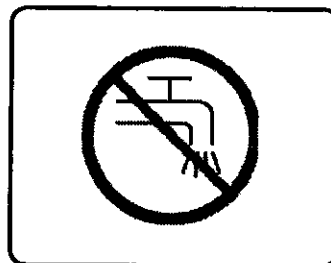

DO NOT FEED WITH DRINKING WATER. USE AN EN 12729 TYPE BA SYSTEM SEPARATOR.

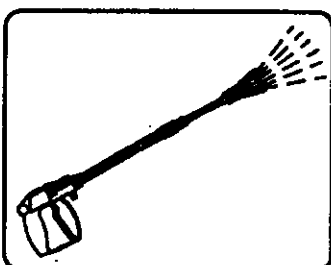

WATER OUTPUT.

CLASSIFICATION OF RISKS:

⚠ Danger
Identifies an imminent risk which could lead to serious or fatal injury.

⚠ Warning
Identifies a risk situation which could lead to serious injury.

Information
Identifies a risk situation which could lead to minor injury or damage to things.

PREFACE

⚠ Warning
You must read this manual before installing, starting up and using the high pressure washer.
This manual is an integral part of the product.

Read the warnings and instructions contained in the manual carefully as they provide important information on **USER SAFETY and MAINTENANCE**, paying particular attention to the general safety regulations.

KEEP THIS MANUAL IN A SAFE PLACE FOR FUTURE REFERENCE.

⚠ Warning
Those operating and servicing the high pressure washer must be aware of the contents of this manual.

CLASSIFICATION

The user must observe the conditions of use of the appliance prescribed by the Rules, and particularly he must respect the following classification:

As for the protection against electric shock, the H.P. cleaner belongs to **CLASS I**.

The H.P. cleaner is factory set and all its safety devices are sealed. **It is forbidden to alter their adjustment values.**

In the Hot water cleaner the water is heated by a burner feed with **Diesel** fuel.

The H.P. cleaner must be always used on a firm and flat ground, furthermore it must not be moved while it is working or connected to the electric supply.

Failure to observe this prescription may cause danger for the user.

The H.P. cleaner must not be used in the presence of corrosive or potentially explosive atmospheres. (vapours or gas)

GENERAL SAFETY RULES FOR THE USE OF HIGH PRESSURE CLEANERS

⚠ Warning
- The electric connection must be performed by qualified technicians who are able to work in observance of the governing rules (in compliance with the provisions of the IEC 60364-1 standard) and of the manufacturer's instructions.

A wrong electric connection may cause damage to persons, animals or things, and the manufacturer cannot be considered responsible for these.

- The H.P. cleaners with power lower than 3 kW are equipped with a plug for connection to the electric supply.

In this case please check if the electric power system and the electric sockets are compatible with the max. power of the appliance indicated on the plate. (kW). In case of doubt, please apply to qualified personnel. If the socket and the plug of the machine are not compatible, have the plug replaced with a suitable type by qualified personnel.

- Before connecting the machine make sure that the data indicated on the plate correspond to those of the electric supply.

- Do not use extensions to power the high pressure washer.

If you use an extension, the plug and socket must be watertight. Unsuitable extensions may be dangerous.

- The electric safety of this machine may be assured only when it is properly connected to an efficient grounding system in accordance with the governing laws for electric safety. (In compliance with the provisions of the IEC 60364-1 standard)

English

- It is necessary to check this essential safety requisite. In case of doubt, ask for accurate control of the power system by qualified personnel.

The manufacturer may not be considered responsible for damages occurred because of the lack of the grounding system.

- The H.P. cleaner must be connected to the electric supply by means of an omnipolar switch with opening contacts of at least 3 mm. This switch must have electric features which are consistent with the appliance. (This requisite does not apply to H.P. cleaners with plug and electric power lower than 3 kW).

It is recommended that the electric supply to this machine should include a residual current device that will interrupt the supply if the leakage current to earth exceeds 30 mA for 30 ms or a device that will prove the earth circuit.

- The appliance is disconnected from the electric supply only by pulling out the plug or switching off the omnipolar switch.

- Failure to respect the above absolves the manufacturer of all liability and represents negligent use of the product.

The water cleaner is considered as a fixed device.

- Water cleaners with the "Total Stop" device should be considered as off when the omnipolar switch is in the "O" position or the plug is unplugged from the socket.

- The appliance must be attended during operation.

- The high pressure washer is not intended for use by children, adolescents or persons with reduced physical, sensory or mental capabilities, under the influence of alcohol

or lacking experience and knowledge.

Operators must be made aware of the instructions for using the appliance by a person responsible for their safety.

Children must be supervised to ensure they do not play with the high pressure washer.

- Use only original accessories that can allow safe working of the appliance.

- The flexible hose connecting the lance to the H.P. cleaner must not be damaged. In case of damage, replace it immediately. The hose must be marked with the admissible pressure value, production date and manufacturer's name.

- Hoses, connections and fittings for high pressure systems are very important to guarantee the safety of the H.P. cleaner. Use only original spare parts which have the manufacturer's approval.

- Do not use the H.P. cleaner when persons or animals are in its of action field.

- High pressure jets may be dangerous if not properly used.

The jet must never be directed at persons or animals, electric appliances or at the appliance itself.

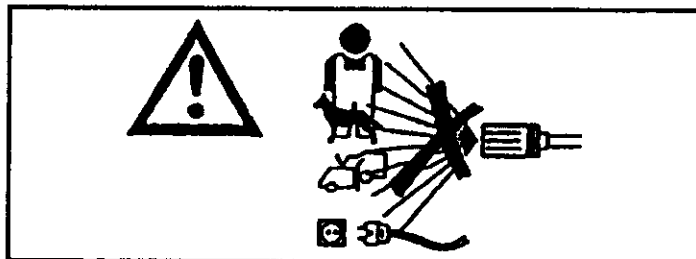

- The high pressure water jet causes a reaction power on the lance. Hold the lance grip vigorously.

- The use of the H.P. cleaner must be considered according to the kind of washing which must be performed.

Protect yourself against the ejection of solid

English

materials or corrosive substances by means of adequate protective clothing.

- The use of the H.P. cleaner must be considered according to the place where the washing is performed (for example: food plants, pharmaceutical plants, etc.) Pertinent rules and safety conditions must be followed.

- Do not direct water jets at your own or other people's body in order to clean clothes or shoes.

- While working it is forbidden, to stop the trigger (lever) of the lance in delivery position.

- In the hot water H.P. cleaners a Diesel fuel burner is used for water heating. The use of other fuels is dangerous.

- Before starting any cleaning or maintenance operation, disconnect the machine from the electric and water supply networks.

- Periodically, at least once a year, have the safety devices checked by one of our service centres.

- The machine is for outdoor use. If the appliance is to be used in an enclosed space (**not advisable**), install a flue gas extraction system and guarantee adequate ventilation.

- Do not clog the openings or the ventilation grilles and the heat and smoke extraction systems in the hot water cleaners.

- Do not use the machine if the supply cable is damaged.

For the replacement of the damaged cable apply exclusively to one of our technical service centres.

The supply cable of this appliance must not be replaced by the user.

- The electric power cable must never be under mechanical tension and must be protected against accidental crushing.

- The use of any electric appliance requires the respect of some basic rules:

- Do not touch the appliance with wet or damp hands or feet.

- Do not use the appliance bare-footed or with unsuitable clothing.

- Do not pull the supply cable or the appliance itself in order to disconnect the plug from the electric supply.

(For water cleaners rated at less than 3 kW fitted with plug).

- In case of damage or malfunction, switch off the appliance (disconnecting it from the water main and from the electricity main via the omnipolar switch or by unplugging the plug in the case of water cleaners rated at less than 3 kW) without tampering with it.

- In the event of accidents, seek medical advice or emergency treatment.

As for the protection against electric shock, the H.P. cleaner belongs to **CLASS I**.

Apply to one of our technical service centres.

Failure to observe the above warning frees the manufacturer from all responsibility and constitutes negligent use of the product.

English

INTENDED USE

This appliance is intended exclusively for cleaning machines, vehicles, buildings and general surfaces suitable for treatment with a high pressure jet of detergent solution between 25 and 250 bar (360 - 3600 PSI).

This appliance has been designed for use with the detergents supplied or recommended by the manufacturer. The use of other detergents or chemicals may influence the safety of the appliance.

This appliance must be used only for the purpose for which it was specifically designed.

All other uses are to be considered incorrect and therefore unreasonable.

Examples of unreasonable use:

- Washing surfaces not suitable for cleaning with a high pressure jet.
- Washing people, animals, electric equipment or the machine itself.
- Using unsuitable detergents or chemicals.
- Blocking the trigger (lever) of the lance in delivery position.

The manufacturer cannot be held responsible for any damage due to improper, incorrect or unreasonable use. As far as safety rules are concerned, the cleaners are manufactured according to the European Standard.

PRELIMINARY OPERATIONS

UNPACKING

After unpacking, ensure that the cleaner is undamaged. If in doubt, do not use the machine. Contact your dealer.

Packaging (bags, boxes, nails, etc) is potentially dangerous and should be kept out of reach of children. It should be disposed of or retained in respect of national environmental legislation.

FITTING THE SEPARATE PARTS OF THE MACHINE

All the fundamental parts and safety devices of the machine are assembled by the manufacturer. For reasons of packing and transport, some secondary cleaner parts are supplied separately. The user must fit these parts as explained in the instructions supplied in each assembly kit.

DATA PLATE:

The data plate bearing the main technical characteristics of your cleaner is located on the trolley and is always visible.

⚠ Warning When buying your cleaner, ensure that it has an identification plate. If there is no plate, inform the manufacturer and/or the dealer immediately. Machines without a plate must not be used and the manufacturer declines all responsibility for them. Products without a plate must be considered anonymous and potentially dangerous.

FILLING THE FUEL TANK

Fill the tank with fuel for Diesel motors (fig. 1).

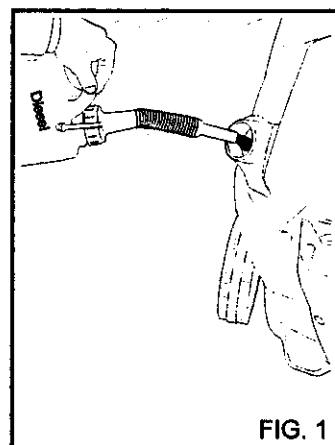

FIG. 1

⚠ Warning

Do not use different fuel from that indicated on the identification plate.

Check the fuel level from time to time while the cleaner is operating.

Attempting to use the cleaner without fuel may cause damage to the fuel pump.

FILLING THE DETERGENT TANK

⚠ Warning

From the range of recommended products, choose the one most suited to the washing job to be done (fig. 2) and dilute it with water according to the instructions on the pack.

Fill the detergent tank with the diluted product (fig. 3).

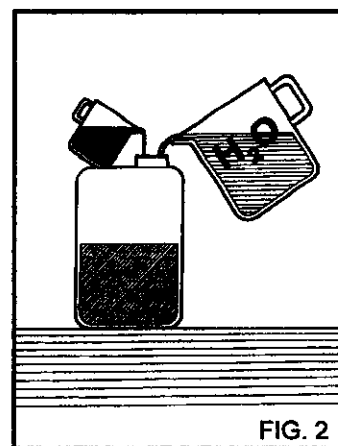

FIG. 2

Ask your dealer for the catalogue of the detergents that can be used depending on the type of washing job to be done and the type of surface to be treated.

After using a detergent, the detergent intake circuit must be flushed out with clean water.

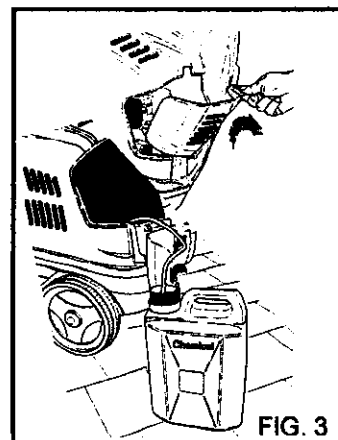
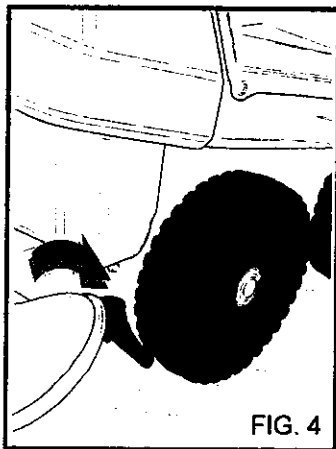

FIG. 3

English

TRANSPORTING

To move the machine, disconnect it from the mains electricity and water supplies, release the parking brake on the side of the machine and push it by the handle.



COMMAND AND CONTROL DEVICES

⚠ Warning

Before connecting the machine to the water supply and to the power mains, it is essential to know the function of the cleaner's command and control devices.

SAFETY DEVICES

The safety devices protect the user and the appliance. They must not be tampered with or used for other than their designated purpose.

Safety valve: protects the high pressure hydraulic circuit in the event of a by-pass valve malfunction or if the hydraulic circuit is blocked.

The safety valve is calibrated by the Manufacturer and sealed.

Operations involving the safety valve must be performed by a technical service centre only.

Safety device on lance handgrip: Prevents the trigger on the handgrip from being operated accidentally.

Thermal cutout: stops the high pressure washer if the electric motor overheats.

WATER CIRCUIT CONNECTION

Connect the feed hose to the mains (fig. 5A) and to the hose-tail on the cleaner (fig. 5B). Check that the pressure and quantity of the water supplied by the mains are sufficient for the cleaner to work properly: 200 to 800 kPa (29 to 116 PSI). Maximum temperature of feeding water 50°C (122°F).

Connect the high pressure hose to the cleaner (fig. 5C) and to the lance (fig. 6).

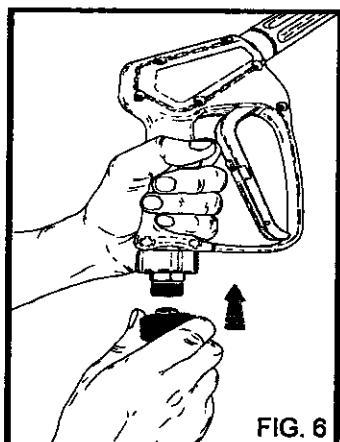
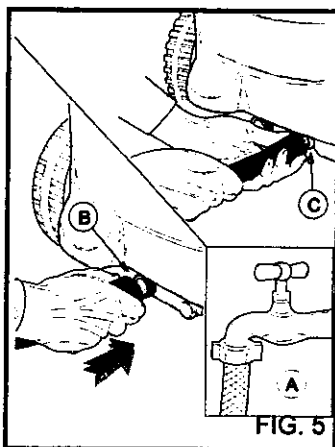

⚠ Danger

The cleaner must operate with clean water. Dirty or sandy water, corrosive chemicals and solvents can cause severe damage to the cleaner.

⚠ Danger

Never suck up liquids containing solvents or acids in the pure state, for example petrol, paint solvents or diesel. The spray mist from the lance is highly inflammable, explosive and poisonous.

Failure to respect the above absolves the manufacturer of all liability and represents negligent use of the product.



Information

Respect the instructions provided by the water utility company.

Current regulations specify that the appliance may not be connected to the drinking water supply unless a suitable system separator is fitted.

Use a suitable EN 12729 type BA system separator.

Water passing through a system separator is no longer classified as drinking water.

⚠ Warning

Do not connect the machine to a drinking water container.

ELECTRICAL CONNECTION

The water cleaner must be connected to a mains electricity supply conforming to current legislation and standards.

Ensure that the mains voltage available is the same as the voltage at which the cleaner is supposed to work; this is indicated on the identification plate.

⚠ Danger

- The electric cable must be protected from accidental crushing.

- Do not use the machine if the supply cable is damaged.

- The use of any electric appliance requires the respect of some basic rules:

- Do not touch the appliance with wet or damp hands or feet.
 - Do not use the appliance bare-footed or with unsuitable clothing.
 - Do not pull the supply cable or the appliance itself in order to disconnect the plug from the electric supply.
- (For water cleaners rated at less than 3 kW fitted with plug).

As for the protection against electric shock, the H.P. cleaner belongs to **CLASS I**.

Failure to observe the above warning frees the manufacturer from all responsibility and constitutes negligent use of the product.

English

USING THE CLEANER

CONTROL PANEL

- A - On/off switch
- B - Temperature regulator

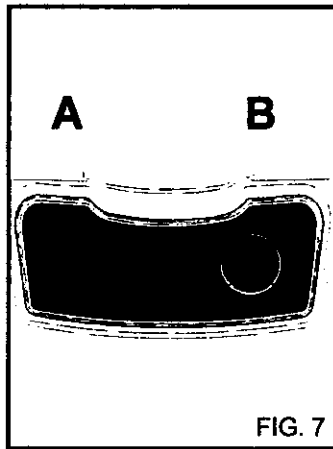

STARTING THE CLEANER

- 1) Turn on the water supply tap (fig. 5A).
- 2) Connect the water cleaner to the mains electricity supply by plugging the plug into the socket.
- 3) Start the cleaner by turning the selector switch to pos. I (fig. 7A).

⚠ Warning

The high pressure water jet generates a reaction force in the lance. Keep a firm grip on the lance handle.

- 4) Press the trigger on the gun and begin washing.
- 5) To operate the water cleaner with hot water, turn the temperature regulator to the recommended washing values. (fig. 7B).

⚠ Warning

In water cleaners with the "Total Stop" system, the motor starts and stops when the lever on the lance handle is actioned or released.

⚠ Danger

Do not block the handle lever in the delivery position.

IMPORTANT!

To eliminate any impurities or air bubbles from the water circuit we advise starting the cleaner for the first time without the lance and letting the water run out for a few seconds.

Impurities could block the nozzle and cause malfunction (Fig. 8).

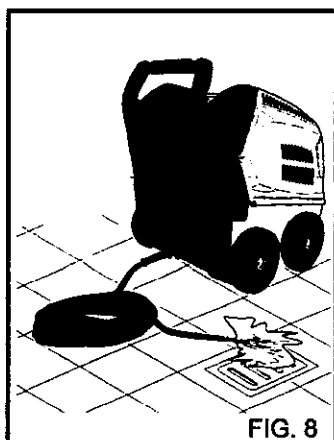

USING THE ACCESSORIES.

The high pressure washer has a nozzle with a flat angle jet for cleaning large surfaces.

ROTARY HEAD (optional accessory)

The high pressure washer can be fitted with a head with rotary nozzle to clean the most stubborn dirt.

⚠ Danger:

Aim the jet from a certain distance to avoid damage caused by the high pressure.
Do not aim the jet at people, animals or electrical sockets.

STOPPING THE CLEANER

- 1) Switch off the burner by turning the pressure regulator to pos. "0" (fig. 7B).
- 2) Let the cleaner run with cold water only for at least 30 seconds to cool down the boiler.
- 3) Stop the cleaner by turning the selector switch to pos. "0" (fig. 7A).
- 4) Discharge the pressure from the H.P. hose by pressing the trigger on the gun.
- 5) Disconnect the water cleaner from the mains electricity supply via the Solenoid switch or by unplugging the plug from the socket.
- 6) Turn off the water supply tap (fig. 5A).

⚠ Warning

- If the water cleaner is left, even temporarily, turn it off by using the Solenoid switch or by unplugging the plug from the socket.

- Water cleaners with the "Total Stop" device should be considered as off when the Solenoid switch is in the "O" position or the plug is unplugged from the socket.

- When the water cleaner is not used, close the safety device on the handle.(fig. 9).

- Dry use of the water cleaner causes serious damage to pump gaskets.

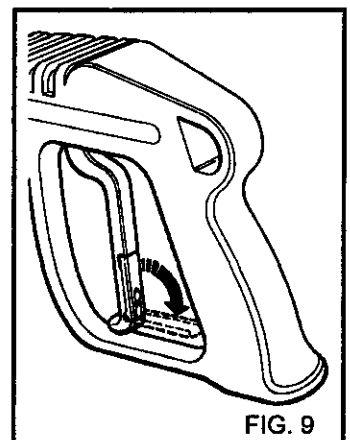

English

REGULATING PRESSURE.

This chapter concerns only those models provided with the "pressure regulating" device. The pressure regulator, fig. 10, allows the operator to adjust the working pressure. When knob C is turned in an anti-clockwise direction (B) (minimum), the working pressure is reduced.

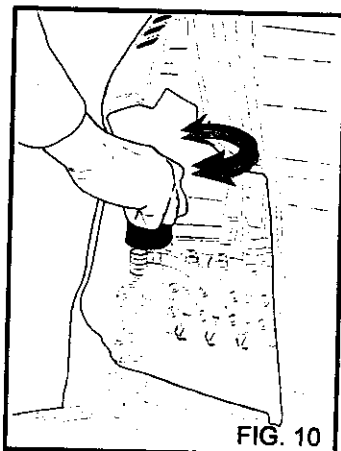

USING STEAM. (If Available)

Use the steam nozzle (supplied as an accessory).

Turn the thermostat knob "B" (fig. 8) to steam position to obtain an increase in the temperature of the water at delivery. At work temperatures higher than 95°C (203°F), the work pressure must be ≤ 32 bar (460 PSI).

⚠ Danger

During use with boiling water, "Steam Phase", keep away from the openings for fumes discharge (risk of burning). When you have finished using the "Steam Phase", turn the thermostat knob "B" to position "0" (fig. 8) and let the machine cool down for about 3 minutes with the gun turned on.

USING THE ADJUSTABLE HEAD (Fig. 11)

To use the detergent solution, an extension wand must be installed, fitted with adjustable head (supplied as an optional accessory).

The adjustable head enables you to select a low or high pressure jet. The pressure is selected by rotating the head. High pressure pos. A. Low pressure pos. B.

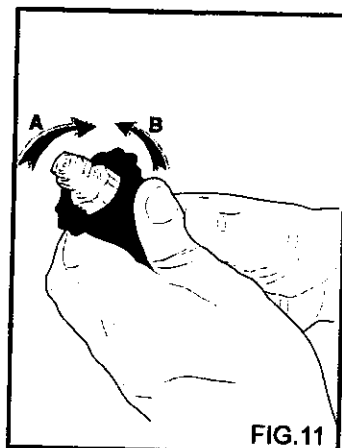

ADVICE ON USING DETERGENTS

⚠ Warning

This cleaner has been designed for use with the detergents supplied or recommended by the manufacturer. The use of other detergents or chemicals may influence the safety of the cleaner.

-) For environmental compatibility, we recommend a reasonable use of detergents, according to the instructions on the pack.
-) From the range of recommended products, choose the one most suited to the washing job to be done and dilute it with water according to the instructions on the pack or in the catalogue of the detergents most suited for the type of hot or cold water cleaner.
-) Ask your dealer for the detergents catalogue.

OPERATING PHASES FOR CORRECT CLEANING WITH DETERGENTS.

- 1) Prepare the solution of detergent at the concentration most suitable for the type of dirt and the surface that is to be washed.
- 2) Start the cleaner, activate the detergent suction control on the lance (fig. 11) and spray the surface to be washed, working from the bottom upwards. Leave to work for a few minutes..
- 3) Rinse the whole surface well from top to bottom with hot or cold water at high pressure.
- 4) After use with detergent, flush out the intake circuit; place the detergent suction hose in a tank of clean water and let the pump run for 1 minute with the dosing tap turned fully on and the lance in detergent delivery condition.

MAINTENANCE

ONLY THE OPERATIONS AUTHORIZED IN THIS INSTRUCTIONS MANUAL MAY BE CARRIED OUT BY THE USER.

ALL OTHER OPERATIONS ARE FORBIDDEN.

⚠ Danger

For maintenance of the boiler, high pressure pump, the electrical parts and all parts with a safety function, you must apply to our Technical service centre.

The manufacturer is not liable in case of tampering, changes, incorrect repairs or maintenance carried out on the machine by a third person not provided with the manufacturer's authorization.

All documents pertaining to the repair and planned service interventions, as well as any certificates concerning the device installation according to the laws in force (in compliance with the provisions of the IEC 60364-1 standard) must be kept carefully by the user, together with the Instructions Manual.

Periodically, at least once a year, have the safety devices and the rated values checked at one of our technical service centres.

Particularly, as for the hot water high pressure cleaner, which is factory set, the exhaust system must be checked.

The rating done by the manufacturer determines a production of exhaust gases with a CO content lower than 0,04% and a smoke content corresponding to a smoke point nr.2 Shell-Bacharach according to the laws in force.

⚠ Danger

Disconnect the water cleaner from the mains electricity supply via the omnipolar switch or by unplugging the plug from the socket and close the water supply tap (see chapters on connecting to the electricity and water mains) before carrying out any maintenance jobs. Once maintenance has been completed, ensure that the closing panels have been correctly reassembled and anchored with the screws provided before reconnecting the cleaner to the mains.

Failure to do so may cause a risk of electric shock.

English

PRECAUTIONS AGAINST FROST

The cleaner must not be exposed to frost.

If the cleaner is left in premises where it is exposed to frost, when work is over or for storage, antifreeze must be used to prevent serious damage to the hydraulic circuit.

OPERATIONS FOR USING ANTIFREEZE (fig. 12).

- 1) Turn off the water supply (tap), disconnect the hose and run the cleaner until it is completely empty.
- 2) Stop the water cleaner with the ON/OFF switch in the "O" position.
- 3) Prepare a container with the solution of antifreeze.
- 4) Immerse the tube in the container with the anti-freeze solution.
- 5) Start the water cleaner with the ON/OFF switch in the "I" position.
- 6) Start the cleaner and let it run until antifreeze comes out through the lance.
- 7) Suck up antifreeze with the detergent intake system too.
- 8) Disconnect the water cleaner from the mains electricity supply via the omnipolar switch or by unplugging the plug from the socket.
- 9) For high pressure cleaners provided with water tank, the detergent solution prepared as described in the point 3, must be poured directly into the tank.

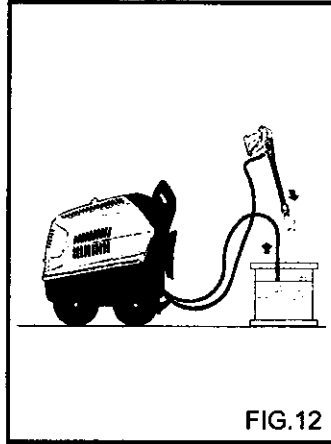

FIG. 12

⚠ Warning

Anti-freeze may cause environmental pollution. Always follow the instructions given on the pack. (Dispose of carefully.)

CHECKING PUMP OIL LEVEL AND OIL CHANGE

From time to time check the oil level in the high pressure pump by means of the sight glass (fig. 13A) or the dipstick (fig. 13B).

If the oil has a milky appearance, call the technical service centre immediately.

Change the oil after the first 50 hours' work and subsequently every 500 hours or once a year.

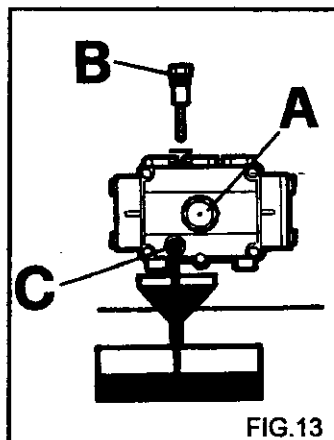

FIG. 13

Proceed as follows:

- 1) Unscrew the drain cap situated under the pump (fig. 13C).
- 2) Unscrew the cap with the dipstick (fig. 13).
- 3) Let all the oil drain off into a container and deliver it to an authorized oil collection and disposal centre.
- 4) Replace the drain screw and pour fresh oil in through the filling cap on top (fig. 14A) until it reaches the level indicated on the sight glass (fig. 14B).

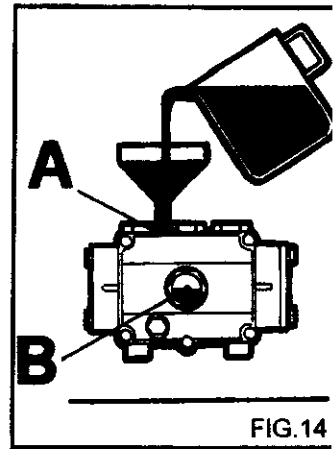

FIG. 14

For water cleaners without oil drain bung, contact our technical service centre for replacement.

Use only SAE 15W 40 oil.

CLEANING THE FUEL FILTER AND TANK.

Remove and replace the in-line fuel filter (fig. 15). Change it from time to time.

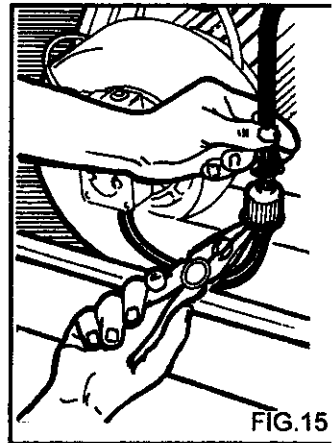

FIG. 15

Empty the fuel tank.

Open the drain cap (fig. 16) (if available) and let any impurities drain out into a container. Flush out the tank with clean fuel and close the drain cap.

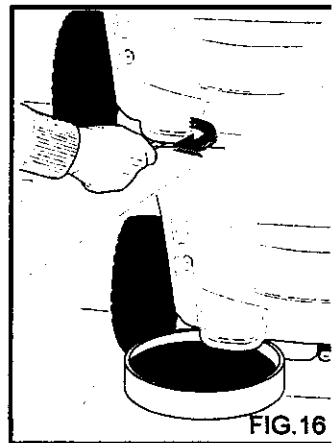

FIG. 16

CLEANING THE WATER FILTER

Clean the water intake filter regularly and free it from any impurities (fig. 17).

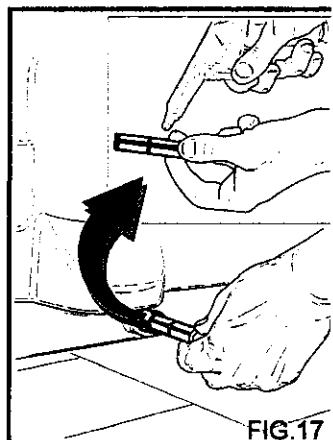

FIG. 17

English

CHANGING THE NOZZLE

The high pressure nozzle fitted on the lance must be changed from time to time, as this component is subject to normal wear during use. Wear may generally be detected by a drop in the working pressure of the cleaner. To replace it, consult your supplier and/or dealer for instructions.

TABLE OF ROUTINE MAINTENANCE TO BE PERFORMED BY THE USER

Description of operations:

Check power cable - pipes - high pressure connectors	Each use
1st oil change in H.P. pump	After 50 hours
Subsequent changes in H.P. pump	Every 500 hours
Change and clean fuel filters	Every 100 hours
Clean fuel tank	Every 100 hours
Clean water filter	Every 50 hours

DESCALING

Descaling must be carried out from time to time because the scale present in the water partially deposits inside the hydraulic circuit and the coil which with time becomes clogged.

Apply to our technical service centre to have the machine descaled from time to time; this will save you money and increase the efficiency of the cleaner.

TABLE OF EXTRAORDINARY MAINTENANCE TO BE PERFORMED BY THE TECHNICAL SERVICE CENTRE

Description of operations:

Boiler:

Clean Coil	Every 200 hours
Descale coil	Every 300 hours
Clean fuel pump	Every 200 hours
Change fuel nozzle	Every 200 hours
Regulate electrodes	Every 200 hours
Change electrodes	Every 500 hours
Change seals on H.P. pump	Every 500 hours
Change lance nozzle	Every 200 hours
Calibrate and check the safety devices	Once a year

IMPORTANT:

These intervals refer to normal working conditions. For heavy duty use decrease the interval for each job. For maintenance and/or repairs, use only original spare parts which offer the greatest characteristics of quality and reliability. Failure to use original spare parts absolves the manufacturer from all liability and transfers it to the person carrying out the operation.

PERIODS OF INACTIVITY

If the machine is to remain inactive for a long period, disconnect the supply sources, drain the tank(s) of all the operating fluids and protect any parts that could be damaged by the accumulation of dust.

Grease the parts that could be damaged by drying out, such as the supply hoses. When bringing back into use, ensure that there are no cracks or cuts in the water supply hoses.

Oil and chemical products must be disposed of according to current legislation.

SCRAPPING

If you no longer wish to use the water cleaner, you should render it unusable by removing the power cable.

You should also make sure that all potentially hazardous parts of the appliance are made safe, particularly for children who could play with the unused water cleaner.

This product is classified as WEEE type special waste and is covered by the requisites of the new environmental protection regulations. It must be disposed of separately from ordinary waste in compliance with current legislation and standards.

Do not use parts dismantled for scrap as spare parts.

English

TROUBLE-SHOOTING

Before carrying out any operations, disconnect the water cleaner from the mains electricity supply via the omnipolar switch or by unplugging the plug from the socket.

FAULTS	CAUSES	REMEDIES
When the switch is turned the cleaner does not start.	Faulty electric connection. Thermal protection has tripped.	Check the mains voltage. Reset (if it trips again, apply to the technical service centre).
No jet or leakage from high pressure water circuit. After 30 seconds, the water cleaner stops. (DS Vers.)	Water supply filter clogged. Faulty connection to the mains water supply. Mains water supply tap closed. Leakage from high pressure circuit.	Clean. Check. Open. Contact Service Centre.
The pump functions but does not reach rated pressure.	Water supply filter clogged. Faulty connection to the mains water supply. Pressure regulation valve is set at minimum. Lance nozzle worn. Valves dirty or worn. Detergent tap open. Pressure adjustment devices on lance open (if present).	Clean. Check. Regulate it. Contact Service Centre. Contact Service Centre. Close. Close.
When the lance is open, the pressure drops and rises.	Nozzle clogged or deformed. Inadequate water supply. Detergent tap open.	Clean or contact Service Centre. Check. Close.
In by-pass or total stop phase, the water cleaner shuts down. (DS Vers.)	Micro-leaks of water from the high pressure circuit.	Contact Service Centre.
When the temperature regulator is brought to the required position, the boiler does not come on.	No diesel. Motor rotation direction incorrect on three-phase models.	Check the level of diesel in the tank and make sure the fuel supply circuit is free of water. Contact Service Centre.
Water not enough.	Temperature regulator position. Filters clogged. Boiler element coated with scale.	Check. Clean or replace. Contact Service Centre.
Excessive smoke from exhaust.	Incorrect combustion. Fuel contaminated with impurities or water.	Clean or replace diesel filters. Contact Service Centre. Empty the tank and clean thoroughly. Clean diesel filters.
Inadequate detergent suction.	Tap closed. No detergent. Element or tube clogged.	Open. Fill the detergent tank. Contact Service Centre.
Water leakage from head.	Gaskets worn.	Contact Service Centre.

English

FAULTS	CAUSES	REMEDIES
Water in the oil.	Excessive humidity in atmosphere.	Replace oil.

IMPORTANT:
For maintenance and/or repairs, use only original spare parts which offer the greatest characteristics of quality and reliability. Failure to use original spare parts frees the manufacturer from all responsibility.

Warranty

As part of an on-going commitment to excellence in product support, Powerblast offers a comprehensive product warranty program.

Registered warranty period for the HW1310:

Machine: 12 Months

Boiler Coil: 2 Years

Accessories: 3 Months

Warranty covers failure caused by manufacturing and material defects in the product, during the warranty period specified. The warranty period begins when the product is purchased by the end user. Warranty is not transferrable and is only claimable by the original purchaser.

Warranty does not cover parts that are subject to wear and tear from usage.

Warranty covers failure of a product caused by defective materials and/or manufacturing for the period given and the usage specified by Powerblast.

The warranty period begins when the product is purchased by the end user. Warranty is not transferrable and is only claimable by the original purchaser.

Warranty also does not cover failure caused by the untimely replacement or service of the above wearing parts. Evidence must be provided that the product has been maintained and serviced suitably for a claim to be considered under warranty.

Failure caused by incorrect operation of the product, lack of proper care and maintenance of the product, external damage, external circumstances such as contaminated fuel or poor water supply, modifications to the product, attempted repair/ service by a party other than an Approved Service Agent, is not covered under warranty.

Warranty does not cover pre delivery service and adjustment, or failure that may occur as a result of lack of/ incorrect pre delivery service and adjustment.

Warranty does not cover any incidental, indirect or consequential loss, damage or expense that may result from any defect, failure or malfunction of a product.

Should any issue be found to be a combination of a warranty failure and a non-warranty issue, the repair cost component to rectify and repair the non-warranty failure is the customers' full responsibility.

The decision that an issue with a product qualifies as a warranty claim is made at the sole jurisdiction of Powerblast.















No costs incurred will be considered under warranty if repairs are carried out by a party other than a Powerblast Approved Service Agent, unless with prior consent in writing from Powerblast.

It is the responsibility of the purchaser to deliver a product under warranty to the nearest relevant service agent or product reseller. Warranty does not cover call outs, mileage and freight costs.

If a product is repaired under warranty, parts and labour required for the repair will be supplied at no charge. Warranty assessment and repair will be scheduled and executed according to the normal work flow at the service location and depending on the availability of suitable replacement parts.

This warranty policy is an additional benefit and does not affect the legal rights of any end user, reseller or service agent.

Technical data

	<ul style="list-style-type: none"> Model 		<p style="text-align: center;">Mod. H 1310</p>
	<ul style="list-style-type: none"> Power supply 	<p>~ v Hz</p>	<p style="text-align: center;">1 230 / 240 50</p>
	<ul style="list-style-type: none"> Absorbed power 	<p>kW W</p>	<p style="text-align: center;">2,8 2800</p>
	<ul style="list-style-type: none"> Pressure 	<p>bar psi</p>	<p style="text-align: center;">40 + 130 580+1800</p>
	<ul style="list-style-type: none"> Flow rate 	<p>l/h gph</p>	<p style="text-align: center;">280 + 600 74 + 160</p>
	<ul style="list-style-type: none"> Fuel consumption Thermal capacity 	<p>kg/h gph kW</p>	<p style="text-align: center;">3,2 0,85 37,8</p>
	<ul style="list-style-type: none"> Water out-put temperature 	<p>°C °F</p>	<p style="text-align: center;">30 + 130 86 + 266</p>
	<ul style="list-style-type: none"> Fuel tank 	<p>l gal</p>	<p style="text-align: center;">18 4,8</p>
	<ul style="list-style-type: none"> Detergent tank 	<p>l gal</p>	<p style="text-align: center;">-</p>
	<ul style="list-style-type: none"> Discaling tank 	<p>l gal</p>	<p style="text-align: center;">-</p>
	<ul style="list-style-type: none"> High pressure hose 	<p>m ft</p>	<p style="text-align: center;">8 26,3</p>
	<ul style="list-style-type: none"> Power cable 	<p>m ft</p>	<p style="text-align: center;">5,5 18</p>
	<ul style="list-style-type: none"> Lance thrust - Vibr. 	<p>N m/s²</p>	<p style="text-align: center;">24 < 2,5</p>
	<ul style="list-style-type: none"> Noise 	<p>Lp dB (A) Lw dB (A)</p>	<p style="text-align: center;">78 94 (kp. 2dB)</p>
	<ul style="list-style-type: none"> Weight 	<p>kg lb</p>	<p style="text-align: center;">80 176,4</p>
	<ul style="list-style-type: none"> Dimensioni Dimensions 	<p>cm in</p>	<p style="text-align: center;">82x69x87 32,3x27,2x34,3</p>

POWER
PREMIUM PRODUCTS

Congratulations on your new POWERSHOT product.

We are proud to have you as our customer and will strive to provide you with the best service and reliability in the industry. This product is backed by our extensive service network. To locate your nearest distributor call 1800 812 223, or email us at sales@powerblast.com.au.